

# TAZOLL GMBH

BATTERIEN & WERKZEUGE

# Beta WORKER

## 2024



**NETTOVERKAUFPREISE  
EXKL. GESETZLICHER MWST.  
GÜLTIG BIS 28/02/2025**

# INDEX

**BITS****3****STECKSCHLÜSSELSÄTZE****3-9****WERKZEUGKOFFER, WER-  
ZEUGKISTEN UND TROLLEYS****10-17****WERZEUGWAGEN  
MIT SORTIMENT****18-29****SORTIMENT  
C45PRO****30**

Beta Worker ist die Werkzeuglinie, die auf die Bedürfnisse von Fachleuten zugeschnitten ist und wesentliche und funktionelle Lösungen bietet, die sich durch ein hervorragendes Qualitäts-/Preisverhältnis auszeichnen. Wählen Sie das Sortiment, das Ihren Bedürfnissen am nächsten kommt, und Sie werden Ihren idealen Partner für die tägliche Arbeit finden.



008606992



## BW 860EA/31

Sortiment mit 30 Schraubeinsätzen und magnetischem Schraubeinsatzhalter, im Kunststoffkasten

X  
31

	BW 861LP	●	0,5x3-0,6x4,5-0,8x5,5-1,0x5,5-1,2x6,5-1,6x8 mm
	BW 861PH	⊕	PH1-PH2-PH3
	BW 861PZ	⊕	PZ1-PZ-PZ3
	BW 861PE	○	2-3-4-5-6-8 mm
	BW 861TX	⊗	T8-T9-T10-T15-T20-T25-T27-T30-T40
	BW 861PQ	○	1-2-3 mm
	BW 882M1	○ 1/4 - ● 1/4	

€ 27,60 inkl. MwSt.

€ 23,00



012566122



## BW 1256/C21-1

Sortiment mit 21 Schraubeinsätzen und magnetischem Schraubeinsatzhalter, im Kunststoffkasten

X  
22

€ 22,20 inkl. MwSt.

€ 18,50

	BW 1256LP	●	1,5-2-2,5 mm
	BW 1256PH	⊕	PH0-PH1
	BW 1256PZ	⊕	PZ0-PZ1
	BW 1256PE	○	0,7-0,9-1,3-1,5-2-2,5-3 mm
	BW 1256TX	⊗	T4-T5-T6-T7
	BW 1256RTX	⊗	T8-T10-T15
		4 mm	99 mm



009036042

1/4"

## BW 903E/C42

Sortiment mit 13 Sechskant-Steckschlüsseln, 18 Schraubeinsätzen, 4 Sechskant-tiftschlüsseln, gebogen, und 7 Betätigungswerkzeugen, im Kunststoffkasten

X  
42

	BW 900	○	4-4,5-5-5,5-6-7-8-9-10-11-12-13-14 mm
	BW 900E/55	⊗	126 mm
	BW 900/25		
	BW 900/20		50 mm
	BW 900/20L		100 mm
	BW 900/42		115 mm
	BW 900/30		150 mm
	BW 96	○	1,3-1,5-2-2,5 mm
	BW 895/1	□ 1/4 - ○ 1/4	
	BW 861LP	●	0,6x4-0,8x5,5-1,2x6,5 mm
	BW 861PH	⊕	PH1-PH2-PH3
	BW 861PZ	⊕	PZ1-PZ2-PZ3
	BW 861PE	○	3-4-5-6 mm
	BW 861TX	⊗	T10-T15-T20-T25-T30

€ 61,80 inkl. MwSt.

€ 51,50

190x160x60 mm



☎ 009136033

**3/8"**









## BW 913E/C33

Sortiment mit 28 Sechskant-Steckschlüsseln  
und 5 Betätigungswerkzeugen,  
im Kunststoffkasten

€ 93,00 inkl. MwSt.

**€ 77,50**

**X  
33**

	BW 910A	○	6-7-8-9-10-11-12-13-14-15-16-17-18-19-20-21-22-24 mm
	BW 910AL	○	8-9-10-12-13-14-17-19 mm
	BW 956C	○	16 mm (5/8") 21 mm (13/16")
	BW 910E/55	⊗	200 mm
	BW 910/25		
	BW 910/20		75 mm
	BW 910/22		150 mm
	BW 920/15F	□ 1/2" - ■ 3/8"	

☞ 285x210x84 mm



**1/2"**

☎ 009236025







## BW 923E/C25

Sortiment mit 20 Sechskant-Steckschlüsseln  
und 5 Betätigungswerkzeugen,  
im Kunststoffkasten

€ 108,00 inkl. MwSt.

**€ 90,00**

**X  
25**

	BW 920A	○	8-9-10-11-12-13-14-15-16-17-18-19-20-21-22-23-24-27-30-32 mm
	BW 920E/55	⊗	264 mm
	BW 920/25		
	BW 920/21		125 mm
	BW 920/22		250 mm
	BW 910/16F	□ 3/8" - ■ 1/2"	

☞ 285x210x84 mm





009236017





## BW 923E-FTX/C17

Sortiment mit 17 Steckschlüsseln für Torx®-Schrauben, im Kunststoffkasten

€ 60,60 inkl. MwSt.

**€ 50,50**

	BW 920FTX	⊙	E10-E12-E14-E16-E18-E20-E22-E24
	BW 920TX	⊙	T20-T25-T27-T30-T40-T45-T50-T55-T60

285x210x84 mm

X  
17



009236028





## BW 923E-PE/C18

Sortiment mit 18 Sechskant-Steckschlüsseln im Kunststoffkasten

€ 93,00 inkl. MwSt.

**€ 77,50**

 55 mm	BW 920PE	⊙	4-5-6-7-8-10-12-14-17-19 mm
 100 mm	BW 920PE-L	⊙	4-5-6-7-8 mm
 140 mm	BW 920PE-XL	⊙	10-12-14 mm

285x210x84 mm

X  
18



009236018





## BW 923E-TX/C18

Sortiment mit 18 Steckschlüsseln für Torx®-Schrauben im Kunststoffkasten

€ 85,20 inkl. MwSt.

**€ 71,00**

 55 mm	BW 920TX	⊙	T20-T25-T27-T30-T40-T45-T50-T55-T60-T70
 100 mm	BW 920TX-L	⊙	T20-T25-T27-T30-T40
 140 mm	BW 920TX-XL	⊙	T45-T50-T55

285x210x84 mm

X  
18



009286017

3/4"

## BW 928E/C17

Sortiment mit 12 Sechskant-Steckschlüsseln und 5 Betätigungswerkzeugen, im Kunststoffkasten

€ 309,60 inkl. MwSt.

€ 258,00

	BW 928A	○	22-24-27-30-32-34-36 38-41-46-50-55 mm
	BW 928/55	⊕	500 mm
	BW 928/25		
	BW 928/21		100 mm
	BW 928/22		200 mm
	BW 928/42		455 mm

555x370x92 mm

X  
17



009036098

1/4" 1/2"









## BW 903E/C98

Sortiment mit 45 Sechskant-Steckschlüsseln, 35 Schraubeinsätzen, 4 Sechskant-Stiftschlüsseln, gebogen, und 14 Betätigungswerkzeugen, im Kunststoffkasten





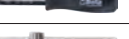

€ 176,40 inkl. MwSt.

€ 147,00

1/4"















	BW 900	○	4-4,5-5-5,5-6-7-8-9-10-11-12-13-14 mm
	BW 900L	○	6-7-8-9-10-11-12-13 mm
	BW 900E/55	⊕	126 mm
	BW 900/25		
	BW 900/20		50 mm
	BW 900/20L		100 mm
	BW 900/30		150 mm
	BW 900/42		115 mm

1/2"

	BW 920A	○	10-11-12-13-14-15-16-17-18-19-20-21- 22-24-27-30-32 mm
	BW 920AL	○	14-15-17-19-22 mm
	BW 956C	○	16 mm (5/8") - 21 mm (13/16")
	BW 920E/55	⊕	264 mm
	BW 920/25		
	BW 920/21		125 mm
	BW 920/22		250 mm

X  
98

375x295x84 mm

	BW 910/16F	□ 3/8" - ■ 1/2"
	BW 895/6	□ 1/2" - ○ 5/16"
	BW 895/1	□ 1/4" - ○ 1/4"
	BW 892/0	● 1/4" - ■ 1/4"
	BW 861PH	⊕ PH1-PH2
	BW 861PZ	⊕ PZ1-PZ2
	BW 861PE	○ 3-4-5-6 mm
	BW 861LP	● 0,6x4-0,8x5,5-1,2x6,5 mm
	BW 861TX	⊕ T10-T15-T20-T25-T27-T30
	BW 866LP	● 1,6x8-1,6x10-2,0x12 mm
	BW 866PH	⊕ PH3-PH4
	BW 866PZ	⊕ PZ3-PZ4
	BW 866PE	○ 7-8-10-12-14 mm
	BW 866TX	⊕ T40-T45-T50-T55-T60-T70
	BW 96	○ 1,3-1,5-2-2,5 mm





009036170

**1/4" 3/8" 1/2"**

## BW 903E/C170

Sortiment mit 74 Sechskant-Steckschlüsseln,  
42 Schraubeinsätzen,  
30 Schraubendrehereinsätzen,  
7 Sechskant-Stiftschlüsseln, gebogen,  
und 17 Betätigungswerkzeugen,  
im Kunststoffkasten

**X  
170**

€ 314,40 inkl. MwSt.  
**€ 262,00**

453x375x90 mm



**1/4"**

	<b>BW 900</b>	○	4-4,5-5-5,5-6-7-8-9-10-11-12-13-14 mm
	<b>BW 900L</b>	○	4-5-6-7-8-9-10 mm
	<b>BW 900E/55</b>	⊕	126 mm
	<b>BW 900/25</b>		
	<b>BW 900/20</b>		50 mm
	<b>BW 900/20L</b>		100 mm
	<b>BW 900/30</b>		150 mm
	<b>BW 900/42</b>		115 mm
	<b>BW 900FTX</b>	⊗	E4-E5-E6-E7-E8
	<b>BW 900LP</b>	●	0,8x4-1,0x5,5-1,2x6,5-1,2x8 mm
	<b>BW 900PH</b>	⊕	PH0-PH1-PH2
	<b>BW 900PZ</b>	⊕	PZ0-PZ1-PZ2
	<b>BW 900ME</b>	○	3-4-5-6 mm
	<b>BW 900TX</b>	⊗	T08-T09-T10-T15-T20-T25-T27-T30
	<b>BW 900RTX</b>	⊗	T08-T09-T10-T15-T20-T25-T27-T30

**1/2"**

	<b>BW 920A</b>	○	10-11-12-13-14-15-16-17-18-19-20-21-22-24-27-30-32 mm
	<b>BW 920AL</b>	○	16-17-18-19-22 mm
	<b>BW 920FTX</b>	⊗	E18-E20-E24
	<b>BW 956C</b>	○	16 mm (5/8") - 21 mm (13/16")
	<b>BW 920E/55</b>	⊕	264 mm
	<b>BW 920/25</b>		
	<b>BW 920/21</b>		125 mm
	<b>BW 920/22</b>		250 mm
	<b>BW 910/16F</b>	□	3/8" - 1/2"

**3/8"**

	<b>BW 910A</b>	○	10-11-12-13-14-15-16-17-18-19 mm
	<b>BW 910AL</b>	○	10-11-12-13-14-15 mm
	<b>BW 910FTX</b>	⊗	E10-E11-E12-E14-E16
	<b>BW 956E</b>	○	18 mm (11/16")
	<b>BW 910E/55</b>	⊕	200 mm
	<b>BW 910/25</b>		
	<b>BW 910/22</b>		150 mm

	<b>BW 96</b>	○	0,9-1,5-2-2,5-3-4-5 mm
	<b>BW 895/4</b>	□	3/8" - 5/16"
	<b>BW 895/6</b>	□	1/2" - 5/16"
	<b>BW 895/1</b>	○	1/4" - 1/4"
	<b>BW 892/0</b>	●	1/4" - 1/4"
	<b>BW 861RTX</b>	⊕	T9-T10-T15-T20-T25-T27-T30-T40
	<b>BW 861TX</b>	⊗	T6-T7-T8
	<b>BW 861RIBE</b>	⊗	T7-8-9 mm
	<b>BW 861XZN</b>	○	T5-6-8 mm
	<b>BW 866LP</b>	●	1,6x8-1,6x10-2,0x12 mm
	<b>BW 866PH</b>	⊕	PH3-PH4
	<b>BW 866PZ</b>	⊕	PZ3-PZ4
	<b>BW 866PE</b>	○	T7-8-10-12-14 mm
	<b>BW 866TX</b>	⊗	T40-T45-T50-T55-T60-T70
	<b>BW 866RTX</b>	⊗	T40-T45-T50-T55-T60-T70

020466116



1/2" 1/4"

## BW 2046E/C116

Werkzeugsortiment,  
116-teilig, für allgemeine  
Instandhaltungsarbeiten,  
im Werkzeugkoffer aus Kunststoff

X  
116

€ 300,00 inkl. MwSt.

€ 250,00

453x375x90 mm



1/4"

	BW 900	○	4-4,5-5-5,5-6-7-8-9-10-11-12-13-14 mm
	BW 900L	○	6-7-8-9-10-11-12-13 mm
	BW 900E/55	⊗	126 mm
	BW 900/25		
	BW 900/20		50 mm
	BW 900/20L		100 mm
	BW 900/30		150 mm
	BW 900/42		115 mm

1/2"

	BW 920A	○	10-11-12-13-14-15-16-17-18-19-20-21-22-24-27-30-32 mm
	BW 920AL	○	14-15-17-19-22 mm
	BW 956C	○	16 mm (5/8") - 21 mm (13/16")
	BW 920E/55	⊗	264 mm
	BW 920/25		
	BW 920/21		125 mm
	BW 920/22		250 mm
	BW 910/16F	□ 3/8" - ■ 1/2"	
	BW 895/6	□ 1/2" - ○ 5/16"	

	BW 895/1	□ 1/4" - ○ 1/4"
	BW 892/0	● 1/4" - ■ 1/4"
	BW 861PH	⊕ ⊗ PH1-PH2
	BW 861PZ	⊕ ⊗ PZ1-PZ2
	BW 861PE	○ ⊗ 3-4-5-6 mm
	BW 861LP	● ⊗ 0,6x4-0,8x5,5-1,2x6,5 mm
	BW 861TX	⊗ ⊗ T10-T15-T20-T25-T27-T30
	BW 866LP	● ⊗ 1,6x8-1,6x10-2,0x12 mm
	BW 866PH	⊕ ⊗ PH3-PH4
	BW 866PZ	⊕ ⊗ PZ3- PZ4
	BW 866PE	○ ⊗ 7-8-10-12-14 mm
	BW 866TX	⊗ ⊗ T40-T45-T50-T55-T60-T70
	BW 42	⊗ 7-8-9-10-11-12-13-14-15-16-17-18-19 mm
	BW 96/SC9	○ 1,5-2-2,5-3-4-5-6-8-10 mm



020476008



1/4" 1/2"

X  
108

## BW 2047E/C108

Werkzeugsortiment,  
108-teilig, für allgemeine  
Instandhaltungsarbeiten,  
im Werkzeugkoffer aus Kunststoff

€ 366,00 inkl. MwSt.

€ 305,00

555x370x92 mm



1/4"

	BW 900	○	4-4,5-5-5,5-6-7-8-9-10-11-12-13-14 mm
	BW 900E/55	⊗	126 mm
	BW 900/25		
	BW 900/20		50 mm
	BW 900/20L		100 mm
	BW 900/30		150 mm
	BW 900/42		115 mm

### BW 860EA/31

	BW 861LP	0,5x3-0,6x4,5-0,8x5,5-1,0x5,5-1,2x6,5-1,6x8 mm
	BW 861PH	1-2-3
	BW 861PZ	1-2-3
	BW 861PE	2-3-4-5-6-8 mm
	BW 861TX	T8-T9-T10-T15-T20 T25-T27-T30-T40
	BW 861PQ	1-2-3 mm
	BW 882M1	○ 1/4 - ● 1/4



1/2"

	BW 920A	○	10-11-12-13-14-15-16-17-18-19-20-21-22-24-27-30-32 mm
	BW 956C	○	16 mm (5/8") - 21 mm (13/16")
	BW 920E/55	⊗	264 mm
	BW 920/25		
	BW 920/21		125 mm
	BW 920/22		250 mm
	BW 910/16F	□ 3/8" - ■ 1/2"	

	BW 895/1	□ 1/4" - ◇ 1/4"
	BW 42	⊗ 7-8-9-10-11-12-13-14-15-16-17-18-19 mm
	BW 96/SC9	○ 1,5-2-2,5-3-4-5-6-8-10 mm
	BW 1048	250 mm
	BW 1082BM	160 mm
	BW 1150BM	180 mm
	BW 1166BM	160 mm
	1201E	● 3x75-4x100-5,5x125 6,5x150mm
	1202E	⊕ PH1-PH2
	BW 1370	300 g

020546001



14"

X  
100

## BW 2054E-100

Werkzeugkoffer mit  
Werkzeugsortiment, 100-teilig,  
für allgemeine  
Instandhaltungsarbeiten

- Eingebauter Schaumstoffeinsatz

€ 345,60 inkl. MwSt.

**€ 288,00**

400x300x140 mm



	BW 42	6-7-8-9-10-11-12-13-14-15-16-17-19 mm
	BW 96BPC/SC9	1,5-2-2,5-3-4-5-6-8-10 mm
	BW 1048	250 mm
	BW 1082BM	160 mm
	BW 1150BM	180 mm
	BW 1166BM	160 mm
	1201E	3x75-5,5x100-6,5x150 mm
	1202E	PH0x60-PH1x80-PH2x100 mm
	BW 1253	3,5x100 mm
	BW 1370	300 g
	BW 1692/3	3 m
	1770A	9 mm
	BW 1770RL	10x
	BW 1778SCL	170 mm
	BW 1725CR	150 mm

### BW 860EA/31

	BW 861LP	0,5x3-0,6x4,5-0,8x5,5-1,0x5,5-1,2x6,5-1,6x8 mm
	BW 861PH	1-2-3
	BW 861PZ	1-2-3
	BW 861PE	2-3-4-5-6-8 mm
	BW 861TX	T8-T9-T10-T15-T20-T25-T27-T30-T40
	BW 861PQ	1-2-3 mm
	BW 882M1	1/4 - 1/4



	BW 882P/80	1/4 - 1/4
	BW 895/1	1/4 - 1/4
	BW 900	4-4,5-5-5,5-6-7-8-9-10-11-12-13-14 mm
	BW 900/20	50 mm
	BW 900/20L	100 mm
	BW 900/25	
	BW 900/30	150 mm
	BW 900/42	115 mm
	BW 900/55	150 mm



020546002



14" 3/8"

## BW 2054E-128

Werkzeugkoffer mit  
Werkzeugsortiment, 128-teilig,  
für allgemeine Instandhaltungsarbeiten

• Eingebauter Schaumstoffeinsatz

€ 420,00 inkl. MwSt.

€ 350,00



### BW 860EA/31

	BW 861LP	0,5x3-0,6x4,5-0,8x5,5-1,0x5,5-1,2x6,5-1,6x8 mm
	BW 861PH	1-2-3
	BW 861PZ	1-2-3
	BW 861PE	2-3-4-5-6-8 mm
	BW 861TX	T8-T9-T10-T15-T20 T25-T27-T30-T40
	BW 861PQ	1-2-3 mm
	BW 882M1	○ 1/4 - ● 1/4



### BW 1256/C21-1

	BW 1256LP	1,5-2-2,5 mm
	BW 1256PH	PH0-PH1
	BW 1256PZ	PZ0-PZ1
	BW 1256PE	0,7-0,9-1,3-1,5-2-2,5-3 mm
	BW 1256TX	T4-T5-T6-T7
	BW 1256RTX	T8-T10-T15
4 mm		99 mm



400x300x140 mm

X  
128

	BW 42		7-8-9-10-11-12-13-14-15-16-17-19 mm
	BW 96BPC/SC9		1,5-2-2,5-3-4-5-6-8-10 mm
	BW 1048		250 mm
	BW 1082BM		160 mm
	BW 1150BM		180 mm
	BW 1166BM		160 mm
	1201E		3x75-5,5x100-6,5x150 mm
	1202E		PH0x60-PH1x80-PH2x100 mm
	BW 1128BMX		150 mm
	BW 1370		300 g
	BW 1692/3		3 m
	1771		18 mm
	BW 1771RL		10x
	BW 1833S		105 mm (Batterien 1xAA - nicht inbegriffen)

14"

	BW 895/1		○ 1/4 - □ 1/4
	BW C900		4-4,5-5-5,5-6-7-8-9-10-11-12-13 mm
	BW C900/20L		100 mm
	BW C900/25		
	BW C900/30		150 mm
	BW C900/42		115 mm
	BW C900/55		150 mm

3/8"

	BW C910A		○ 14-15-17-18-19-22-24 mm
	BW C910/22		150 mm
	BW C910/25		
	BW C910/55		200 mm
	BW C920/15F		□ 1/2" - ■ 3/8"

020566010



1/4" 1/2"

## BW 2056E

Werkzeugkoffer mit  
Werkzeugsortiment, 163-teilig,  
für allgemeine Instandhaltungsarbeiten

- Herausnehmbares internes Panel
- Integrierter Schaumstoffeinsatz

€ 541,20 inkl. MwSt.  
**€ 451,00**



465x330x170 mm

020566110



1/4" 1/2"

## BW 2056T/E

Werkzeugtrolley mit  
Werkzeugsortiment, 163-teilig, für  
allgemeine Instandhaltungsarbeiten

- Verstellbarer Teleskopgriff
- Herausnehmbares internes Panel
- Eingebauter Schaumstoffeinsatz

€ 579,60 inkl. MwSt.

**€ 483,00**

465x330x225 mm



## 163-TEILIGES SORTIMENT

	BW 42	8-9-10-11-12-13-14-15-16-17-18-19 mm		1202E	PH1x80-PH2x100 mm
	BW 96BPC/SC9	1,5-2-2,5-3-4-5-6-8-10 mm		1209E/PZ	PZ1x80-PZ2x100 mm
	BW 111	250 mm		BW 1128BMX	150 mm
	BW 1048	250 mm		BW 1253	3,5x100 mm
	BW 1082BM	160 mm		BW 1370	300 g
	BW 1150BM	180 mm		BW 1692/5	5 m
	BW 1166BM	160 mm		BW 1725CR	150 mm
	1201E	2,5x50-3x75-4x125-5,5x150-6,5x150-8x150 mm		1771	18 mm

1/4"

	BW 895/1	○ 1/4 - □ 1/4
	BW 900	○ 4-4,5-5-5,5-6-7-8-9-10-11-12-13-14 mm
	BW 900/20	50 mm
	BW 900/20L	100 mm
	BW 900/25	
	BW 900/30	150 mm
	BW 900/42	115 mm
	BW 900/55	150 mm

1/2"

	BW 920A	○ 10-11-12-13-14-15-16-17-18-19-21-22-24 mm
	BW 920/21	125 mm
	BW 920/22	250 mm
	BW 910/16F	□ 3/8" - ■ 1/2"
	BW 920/25	
	BW 920/55	⊕ 260 mm

### BW 861/C61

	BW 861LP	0,5x3 (2)-0,5x4(2)-0,6x4,5(2)-0,8x5(2)-1,0x5,5(2)-1,0x6(2)-1,6x8(2) mm
	BW 861PH	PH0(2)-PH1(7)-PH2(7)-PH3(2)
	BW 861PZ	PZ0(2)-PZ1(3)-PZ2(3)-PZ3(2)
	BW 861PE	1,5-2-2,5-3-4-4,5-5-5,5-6-8 mm
	BW 861TX	T9-T10-T15-T20-T25 T27-T30-T40
	BW 882M1	○ 1/4 - ● 1/4



### BW 1256/C21-1

	BW 1256LP	1,5-2-2,5 mm
	BW 1256PH	PH0-PH1
	BW 1256PZ	PZ0-PZ1
	BW 1256PE	0,7-0,9-1,3-1,5-2-2,5-3 mm
	BW 1256TX	T4-T5-T6-T7
	BW 1256RTX	T8-T10-T15
	4 mm	99 mm





020566022



X  
147

## BW 2056E 12V/19P

Werkzeugkoffer mit Werkzeugsortiment,  
146-teilig, für allgemeine Wartung,  
und 12V-Bohrschrauber

- Herausnehmbares internes Paneel
- Eingebauter Schaumstoffeinsatz

€ 624,00 inkl. MwSt.

**€ 520,00**



**NEW**



465x330x170 mm

	BW 42		8-9-10-11-12-13-14-15-16-17-18-19 mm
	BW 96BPC/SC9		1,5-2-2,5-3-4-5-6-8-10 mm
	BW 111		250 mm
	BW 1048		250 mm
	BW 1082BM		160 mm
	BW 1150BM		180 mm
	BW 1166BM		160 mm
	1201E		2,5x50-3x75-4x125-5,5x150-6,5x150-8x150 mm
	1202E		PH1x80-PH2x100 mm
	1209E/PZ		PZ1x80-PZ2x100 mm
	BW 1128BMX		150 mm
	BW 1253		3,5x100 mm
	BW 1370		300 g
	BW 1692/5		5 m
	BW 1725CR		150 mm
	1771		18 mm
	BW 1696		300 mm

	1972/12V-10	
	1994BL 12V-2AH	
	1994CB 12V	
	410/SEL19	Ø 1=10x0,5 mm

**1/4"**

	BW 895/1		□ 1/4 - □ 1/4
	BW 900		○ 4-4,5-5-5,5-6-7-8-9-10-11-12-13-14 mm
	BW 900/20		50 mm
	BW 900/20L		100 mm
	BW 900/25		
	BW 900/30		150 mm
	BW 900/42		115 mm
	BW 900/55		150 mm

### BW 861/C61

		BW 861LP	0,5x3 (2)-0,5x4(2)-0,6x4,5(2)-0,8x5(2)-1,0x5,5(2)-1,0x6(2)-1,6x8(2) mm
		BW 861PH	PH0(2)-PH1(7)-PH2(7)-PH3(2)
		BW 861PZ	PZ0(2)-PZ1(3)-PZ2(3)-PZ3(2)
		BW 861PE	1,5-2-2,5-3-4-4,5-5-5,5-6-8 mm
		BW 861TX	T9-T10-T15-T20-T25 T27-T30-T40
		BW 882M1	○ 1/4 - ● 1/4





12"

021206911

## BW 2120L-E/T91

Werkzeugsortiment, 91-teilig, für allgemeine Instandhaltungsarbeiten, im Werkzeugkasten aus Blech

X  
91

€ 426,00 inkl. MwSt.

€ 355,00



550x200x210 mm



BW 42	⊕	8-9-10-11-12-13-14-15-16-17-19 mm	20
BW 96/SC9	○	1,5-2-2,5-3-4-5-6-8-10 mm	



1201E	●	2,5x50-3x75-4x100-5,5x125-6,5x150 mm	6
1201EN	●	4x30 mm	



BW 860EA/31	⊕ ⊖ ⊕ ⊖ ⊕ ⊖ ⊕ ⊖		37
BW 895/1	◇	1/4 - □ 1/4	
BW 900/30		150 mm	
1202E	⊕	PH0x60-PH1x80-PH2x100 mm	
1202EN	⊕	PH1x30 mm	



BW 1082BM	⌒	160 mm	3
BW 1150BM	≡	180 mm	
BW 1166BM	●	160 mm	

12"



BW 920A	○	10-11-12-13-14-15-16-17-18-19-20-21-22-23-24-27-30-32 mm	20
BW 920/55	⊗	250 mm	
BW 920/25			



BW 920/21	○	125 mm	5
BW 920/22		250 mm	
BW 910/16F	□	3/8" - ■ 1/2"	
BW 1048		250 mm	
1771		18 mm	



022006130

## BW C22E

### Werkzeugkasten mit 3 Schubladen

- 3 Schubladen, 435x210 mm, mit Teleskopführungen, kugelgelagert:
- 1 Schublade Höhe 50 mm
- 2 Schubladen Höhe 70 mm
- Oberes Fach, 505x250 mm
- Zentralverriegelung mit vorderem Schloss
- Griff am Deckel
- Versenkbare Seitengriffe für richtige Führung

€ 146,40 inkl. MwSt.

**€ 122,00**

n°	h	↓ max
3	50 mm	5 kg

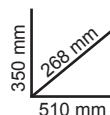

022006201

## BW 2200E/21

### Werkzeugkasten mit 3 Schubladen, mit Werkzeugsortiment, 159-teilig

€ 508,80 inkl. MwSt.

**€ 424,00**



14"

12"

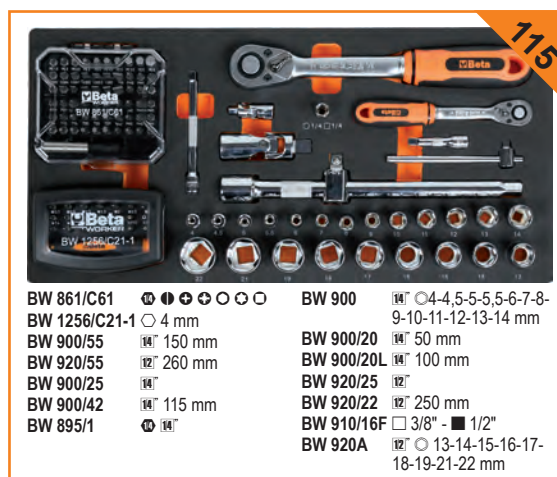

- |               |                 |            |                                   |
|---------------|-----------------|------------|-----------------------------------|
| BW 861/C61    | ⊕ ⊖ ⊕ ⊖ ⊕ ⊖ ⊕ ⊖ | BW 900     | ⊕ ⊖ ⊕ ⊖ ⊕ ⊖ ⊕ ⊖ ⊕ ⊖ ⊕ ⊖           |
| BW 1256/C21-1 | ⊕ 4 mm          | BW 900/20  | ⊕ 50 mm                           |
| BW 900/55     | ⊕ 150 mm        | BW 900/20L | ⊕ 100 mm                          |
| BW 920/55     | ⊕ 260 mm        | BW 920/25  | ⊕                                 |
| BW 900/25     | ⊕               | BW 920/22  | ⊕ 250 mm                          |
| BW 900/42     | ⊕ 115 mm        | BW 910/16F | ⊕ 3/8" - ⊕ 1/2"                   |
| BW 895/1      | ⊕ ⊕             | BW 920A    | ⊕ ⊕ 13-14-15-16-17-18-19-21-22 mm |

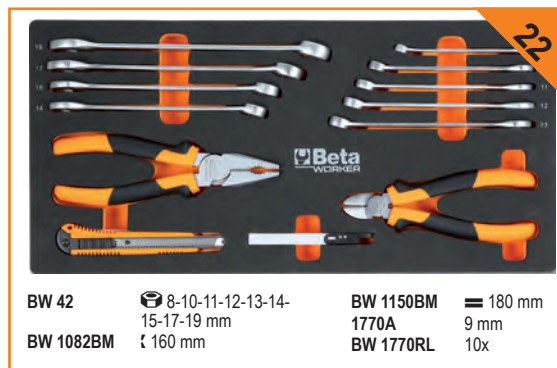

- |           |                                |           |          |
|-----------|--------------------------------|-----------|----------|
| BW 42     | ⊕ 8-10-11-12-13-14-15-17-19 mm | BW 1150BM | ⊕ 180 mm |
| BW 1082BM | ⊕ 160 mm                       | BW 1770A  | ⊕ 9 mm   |
|           |                                | BW 1770RL | ⊕ 10x    |

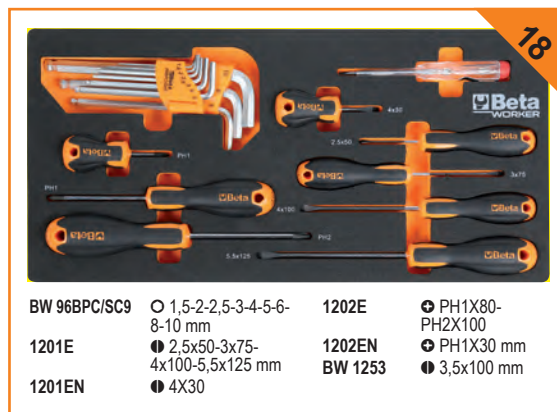

- |              |                                |         |                   |
|--------------|--------------------------------|---------|-------------------|
| BW 96BPC/SC9 | ⊕ 1,5-2-2,5-3-4-5-6-8-10 mm    | 1202E   | ⊕ PH1X80- PH2X100 |
| 1201E        | ⊕ 2,5x50-3x75-4x100-5,5x125 mm | 1202EN  | ⊕ PH1X30 mm       |
| 1201EN       | ⊕ 4X30                         | BW 1253 | ⊕ 3,5x100 mm      |

**X  
159**

	BW 1048	250 mm
	BW 1128BMX	150 mm
	BW 1370	300 g
	BW 1692	5 m

043006003

## BW C43

### Werkzeugtrolley mit drei stapelbaren Modulen

- Rahmen aus Blech und Kunststoff
- 3 getrennte Module:  
1 oberer Korb, Höhe 222 mm  
1 zentrales Modul, Höhe 168 mm, mit 2 Schubladen, Höhe 60 mm  
1 unteres Modul, Höhe 332 mm, mit Schwingtür, Höhe 280 mm, mit Rädern
- Räder ø 128 mm
- In 4 Positionen arretierbarer Teleskopgriff
- Auslösende Module mit Zugriff auf die verschiedenen Werkzeugfächer
- Oberer Korb mit entfernbarer interner Aufbewahrungsschale und 2 im Deckel integrierten Schalen

€ 234,00 inkl. MwSt.

€ 195,00

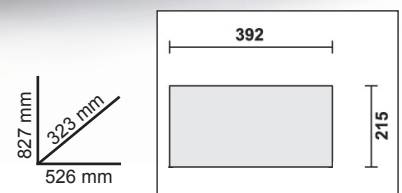

## Drei-Modul Werkzeug-Trolley





043006201

## BW 4300E/21

Werkzeugtrolley mit 3 stapelbaren Modulen, mit Werkzeugsortiment, 212-teilig, für allgemeine Instandhaltungsarbeiten

	BW 42		7-8-9-10-11-12-13-14-15-16-17-18-19-22 mm
	BW 96BPC/SC9		1,5-2-2,5-3-4-5-6-8-10 mm
	BW 111		200 mm
	BW 1048		250 mm
	BW 1052		240 mm
	BW 1082BM		160 mm
	BW 1150BM		180 mm
	BW 1166BM		160 mm
	1201E		2,5x50-3x75-4x100-5,5x150-6,5x150 mm
	1201EN		4x30 mm
	1202E		PH0x60-PH1x80-PH2x100 mm
	1202EN		PH1x30 mm
	BW 1128BMX		150 mm
	BW 1253		3,5x100 mm
	BW 1370		300 g
	BW 1390		∅ 35 mm
	BW 1692		3 m
	BW 1696		300 mm
	1771		18 mm
	BW 1771RL		10x
	BW 1725CR		150 mm
	BW 1098		220 mm
	BW 1719BMA...P		200 mm
	BW 1719BMA...M		200 mm
	BW 1719BMA...R		200 mm
	BW 1833S		105 mm (Batterien 1xAA - nicht inbegriffen)

### BW 861/C61

	BW 861LP	0,5x3 (2)-0,5x4(2)-0,6x4,5(2)-0,8x5(2)-1,0x5,5(2)-1,0x6(2)-1,6x8(2) mm
	BW 861PH	PH0(2)-PH1(7)-PH2(7)-PH3(2)
	BW 861PZ	PZ0(2)-PZ1(3)-PZ2(3)-PZ3(2)
	BW 861PE	1,5-2-2,5-3-4-4,5-5-5,5-6-8 mm
	BW 861TX	T9-T10-T15-T20-T25 T27-T30-T40
	BW 882M1	∅ 1/4 - ● 1/4



€ 729,60 inkl. MwSt.

€ 608,00

X  
212



### BW 1256/C21-1

	BW 1256LP	1,5-2-2,5 mm
	BW 1256PH	PH0-PH1
	BW 1256PZ	PZ0-PZ1
	BW 1256PE	0,7-0,9-1,3-1,5-2-2,5-3 mm
	BW 1256TX	T4-T5-T6-T7
	BW 1256RTX	T8-T10-T15
4 mm		99 mm



### BW 903E/C42

	BW 900		4-4,5-5-5,5-6-7-8-9-10-11-12-13-14 mm
	BW 900E/55		126 mm
	BW 900/25		
	BW 900/20		50 mm
	BW 900/20L		100 mm
	BW 900/42		115 mm
	BW 900/30		150 mm
	BW 96		1,3-1,5-2-2,5 mm
	BW 895/1		1/4 - □ 1/4
	BW 861LP		∅ 0,6x4-0,8x5,5-1,2x6,5 mm
	BW 861PH		∅ PH1-PH2-PH3
	BW 861PZ		∅ PZ1-PZ2-PZ3
	BW 861PE		∅ 3-4-5-6 mm
	BW 861TX		∅ T10-T15-T20-T25-T30



### BW 923E/C25

	BW 920A		8-9-10-11-12-13-14-15-16-17-18-19-20-21-22-23-24-27-30-32 mm
	BW 920E/55		264 mm
	BW 920/25		
	BW 920/21		125 mm
	BW 920/22		250 mm
	BW 910/16F		□ 3/8" - ■ 1/2"





## BW 5000S/3M

X  
**189**

### Werkstatt-servicewagen Mit 3 Schubladen, mit Werkzeugsortiment, 189-teilig

- Arbeitsplatte aus Thermokunststoff
- 3 Schubladen mit Teleskopführungen, kugelgelagert, 588x367 mm, Höhe 70 mm
- Schubladenböden mit Schaumgummibelag
- Zentralverriegelung mit vorderem Sicherheitsschloss
- Praktischer seitlicher Schraubendreherhalter inklusive
- Zwei seitliche Dosenhalter, an der Struktur integriert
- Große untere Ablage, mit öl- und benzinfester Gummischutzmatte
- Vier Räder Ø 125 mm: 2 starre und 2 lenkbare (eins mit Bremse)
- Statische Belastung: 400 kg
- Tragkraft jeder Schublade: 15 kg, Gewicht muss gleichmäßig verteilt sein

400 kg



€ 1.184,40 inkl. MwSt.

**€ 987,00**

n°	h	max
3	70 mm	15 kg



050006331



050006332



050006333

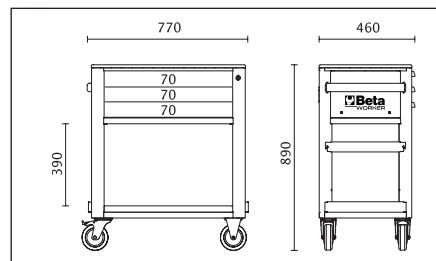
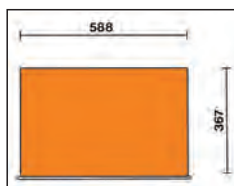

31

- BW 42** 6-7-8-9-10-11-12-13-14-15-16-17-18-19-20-21-22-23-24 mm  
**1201E** 2,5x50-3x75-4x100-5,5x125-6,5x150-8x200 mm  
**1202E** PH0x60-PH1x80-PH2x100-PH3x150 mm  
**1201EN** 4x30 mm  
**1202EN** PH1x30 mm



13

- BW 32** Ø 4 mm  
**BW 34** 150 mm  
**BW 36** 150 mm  
**BW 1048** 250 mm  
**BW 1082BM** ≤ 160 mm  
**BW 1150BM** = 180 mm  
**BW 1166BM** = 200 mm  
**BW 1370** 500 g  
**BW 1390** Ø 35 mm  
**1032** Ø 180 mm  
**1034** Ø 170 mm  
**1036** ● 175 mm  
**1038** ● 175 mm



14

- BW 900** ○ 4-4,5-5-5,5-6-7-8-9-10-11-12-13-14 mm  
**BW 900ME** ○ 3-4-5-6-7-8 mm  
**BW 900TX** ○ T06-T07-T08-T09-T10-T15-T20-T25  
**BW 900/20** 50 mm  
**BW 900/20L** 100 mm  
**BW 900/25**  
**BW 900/30** 150 mm  
**BW 900/42** 115 mm  
**BW 900/55** ⊕ 150 mm  
**BW 895/1** ○ 1/4" - □ 1/4"

- BW 96BPC/SC9** ○ 1,5-2-2,5-3-4-5-6-8-10 mm  
**BW 111** 250 mm

12

- BW 920A** ○ 8-9-10-11-12-13-14-15-16-17-18-19-20-21-22-23-24-27-30-32 mm  
**BW 920PE** ○ 5-6-7-8-9-10-12-14 mm  
**BW 920TX** ○ T27-T30-T40-T45-T50-T55-T60  
**BW 920/21** 125 mm  
**BW 920/22** 250 mm  
**BW 910/16F** □ 3/8" - ■ 1/2"  
**BW 920/25**  
**BW 920/55** ⊕ 260 mm

### BW 861/C61

⊕	BW 861LP	0,5x3 (2)-0,5x4(2)-0,6x4,5(2)-0,8x5(2)-1,0x5,5(2)-1,0x6(2)-1,6x8(2) mm
+	BW 861PH	PH0(2)-PH1(7)-PH2(7)-PH3(2)
+	BW 861PZ	PZ0(2)-PZ1(3)-PZ2(3)-PZ3(2)
○	BW 861PE	1,5-2-2,5-3-4-4,5-5-5,5-6-8 mm
⊕	BW 861TX	T9-T10-T15-T20-T25 T27-T30-T40
□	BW 862M1	○ 1/4 - ● 1/4

145



024006201



## BW C04BOX-A VU

Werkzeugwagen mit 6 Schubladen, mit Werkzeugsortiment 196-teilig für den universellen Einsatz, in weichen EVA-Schaumstoffschalen

- ABS-Arbeitsplatte mit 6 Werkzeugablagen
- 6 Schubladen 570x410 mm, mit kugelgelagerten Führungen:
- Schubladenböden mit Schaumstoffmatten geschützt.
- Vier Räder Ø 125 mm: 2 starre und 2 lenkbare, 1x mit Bremse.
- Zentralverriegelung mit vorderem Sicherheitschloss.
- Statische Belastung: 150 kg



X  
196

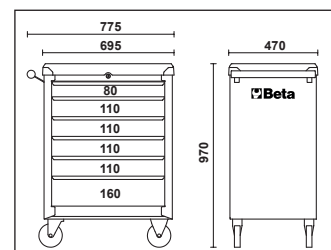
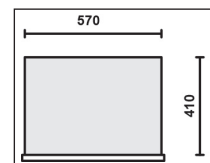

n°	h	max
1	80 mm	20 kg
4	110 mm	20 kg
1	160 mm	25 kg



€ 888,00 inkl. MwSt.

**€ 740,00**



36

- BW 42** 6-7-8-9-10-11-12-13-14-15-16-17-19-21-22-24 mm  
**BW 96BPC/SC9** 1,5-2-2,5-3-4-5-6-8-10 mm  
**BW 1719BMA8/P** 200 mm  
**BW 1719BMA8/M** 200 mm  
**BW 1719BMA8/R** 200 mm
- BW 1128BMX 1201E**  
**1201EN**  
**1202E**  
**1202EN**

- 150 mm  
 ● 3,5x100-5,5x150-6,5x150 mm  
 ● 4x30 mm  
 ● PH1x80-PH2x100 mm  
 ● PH1x30



23

- BW 31** Ø 2-3-4-5-6 mm  
**1771** 18 mm  
**BW 1048** 250 mm  
**BW 1082BM** 160 mm  
**BW 1150BM** 180 mm
- BW 1166BM** ● 160 mm  
**BW 1692/3** 3 m  
**BW 1370** 300 g  
**BW 1390** Ø 35 mm  
**BW 1771RL** 10x 18 mm

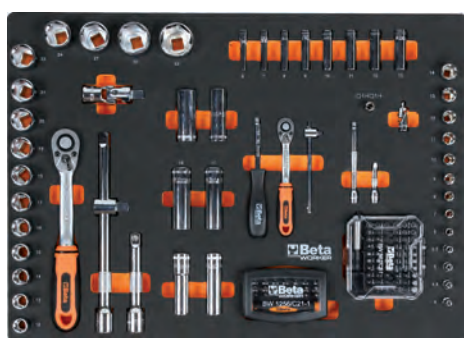

14"

- BW 900** ○ 4-4,5-5-5,5-6-7-8-9-10-11-12-13-14 mm  
 ○ 6-7-8-9-10-11-12-13 mm  
 ○ 1/4 - □ 1/4  
 50 mm  
 100 mm  
 150 mm  
 115 mm  
 150 mm

### BW 861/C61

●	BW 861LP	0,5x3 (2)-0,5x4(2)-0,6x4,5(2)-0,8x5(2)-1,0x5,5(2)-1,0x6(2)-1,6x8(2) mm
+	BW 861PH	PH0(2)-PH1(7)-PH2(7)-PH3(2)
+	BW 861PZ	PZ0(2)-PZ1(3)-PZ2(3)-PZ3(2)
○	BW 861PE	1,5-2-2,5-3-4-4,5-5-5,5-6-8 mm
⊗	BW 861TX	T9-T10-T15-T20-T25 T27-T30-T40
○	BW 882M1	○ 1/4 - ● 1/4

12"

- BW 920A** ○ 12-13-14-15-16-17-18-19-20-21-22-24-27-30-32 mm  
 ○ 14-15-17-19 mm  
**BW 920AL** 125 mm  
**BW 920/21** 250 mm  
**BW 920/22** 250 mm  
**BW 910/16F** □ 3/8" - ■ 1/2"  
**BW 920/25** ⊗ 260 mm  
**BW 920/55** ⊗ 260 mm  
**BW 956C** 16-20,8 mm

### BW 1256/C21-1

●	BW 1256LP	1,5-2-2,5 mm
+	BW 1256PH	PH0-PH1
+	BW 1256PZ	PZ0-PZ1
○	BW 1256PE	0,7-0,9-1,3-1,5-2-2,5-3 mm
⊗	BW 1256TX	T4-T5-T6-T7
⊗	BW 1256RTX	T8-T10-T15
4 mm		99 mm

137



## BW 2400S 7/E-S

Werkzeugwagen mit 7 Schubladen,  
mit Werkzeugsortiment, 240-teilig

Haupteigenschaften:

- 7 Schubladen, 588x367 mm, mit Teleskopführungen, kugelgelagert:
- 5 Schubladen Höhe 70 mm
- 1 Schublade Höhe 140 mm
- 1 Schublade Höhe 210 mm
- Schubladenböden mit Schaumgummibelag
- 4 Räder Ø 125 mm:
- 2 starre und 2 lenkbare (eines mit Bremse)
- Zentralverriegelung mit vorderem Sicherheitsschloss
- Statische Belastung: 800 kg
- Thermokunststoff-Arbeitsplatte
- Integrierter seitlicher Flaschenhalter

X  
240

800 kg



€ 1.278,00 inkl. MwSt.

**€ 1.065,00**



024006221



024006222



024006223

n°	h	max
5	70 mm	25 kg
1	140 mm	30 kg
1	210 mm	30 kg

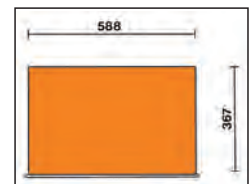
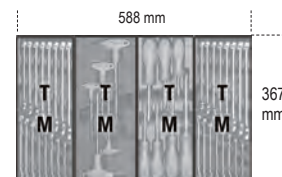

Frontblende aus  
hochbeständigem  
Nylon



Räder mit  
Metallkern für höhere  
Widerstandsfähigkeit

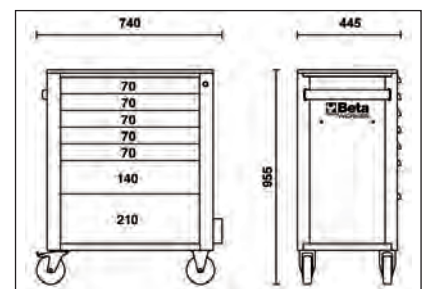





33

1201E	● 2,5x50-3x75-4x100-5,5x125-6,5x150-8x200 mm
1201EN	● 4x30 mm
1202E	⊕ PH0x60-PH1x80-PH2x100-PH3x150 mm
1202EN	⊕ PH1x30 mm
1207E/TX	⊖ T6-T7-T8-T9-T10-T15-T20-T25-T27-T30-T40
BW 96BPC/SC9	○ 1,5-2-2,5-3-4-5-6-8-10 mm

36

**BW 42** 6-7-8-9-10-11-12-13-14-15-16-17-18-19-20-21-22-23-24 mm  
**BW 55** 6x7-8x9-10x11-12x13-14x15-16x17-18x19-20x22 mm  
**BW 90** 6x7-8x9-10x11-12x13-14x15-16x17-18x19-20x22 mm  
**BW 111** 250 mm

13

<b>BW 32</b>	∅ 4 mm	<b>BW 1048</b>	250 mm
<b>BW 34</b>	150 mm	<b>BW 1082BM</b>	160 mm
<b>BW 36</b>	150 mm	<b>BW 1150BM</b>	180 mm
<b>1032</b>	○ 19+60 mm	<b>BW 1166BM</b>	200 mm
<b>1034</b>	○ 19+60 mm	<b>BW 1370</b>	500 g
<b>1036</b>	● 19+60 mm	<b>BW 1390</b>	∅ 35 mm
<b>1038</b>	● 19+60 mm		

159

**14** **BW 900** ○ 4-4,5-5-5,5-6-7-8-9-10-11-12-13-14 mm  
**BW 900L** ○ 4,4-5-5,5-6-7-8-9-10-11-12-13-14 mm  
**BW 900ME** ○ 3-4-5-6-7-8 mm  
**BW 900TX** ⊖ T6-T7-T8-T9-T10-T15-T20-T25  
**BW 895/1** ○ 1/4 - □ 1/4  
**BW 900/20** 50 mm  
**BW 900/20L** 100 mm  
**BW 900/25**  
**BW 900/30** 150 mm  
**BW 900/42** 115 mm  
**BW 900/55** ⊗ 150 mm

12

<b>BW 920A</b>	○ 8-9-10-11-12-13-14-15-16-17-18-19-20-21-22-23-24-27-30-32 mm
<b>BW 920AL</b>	○ 10-12-13-14-15-16-17-18-19-21-22 mm
<b>BW 920PE</b>	○ 5-6-7-8-9-10-12-14 mm
<b>BW 920TX</b>	⊖ T27-T30-T40-T45-T50-T55-T60
<b>BW 920/21</b>	125 mm
<b>BW 920/22</b>	250 mm
<b>BW 910/16F</b>	□ 3/8" - ■ 1/2"
<b>BW 920/25</b>	
<b>BW 920/55</b>	⊗ 260 mm

**BW 861/C61** 14

⊖	<b>BW 861LP</b>	0,5x3 (2)-0,5x4(2)-0,6x4,5(2)-0,8x5(2)-1,0x5,5(2)-1,0x6(2)-1,6x8(2) mm
⊕	<b>BW 861PH</b>	PH0(2)-PH1(7)-PH2(7)-PH3(2)
⊕	<b>BW 861PZ</b>	PZ0(2)-PZ1(3)-PZ2(3)-PZ3(2)
○	<b>BW 861PE</b>	1,5-2-2,5-3-4-4,5-5-5,5-6-8 mm
⊖	<b>BW 861TX</b>	T9-T10-T15-T20-T25 T27-T30-T40
⊖	<b>BW 882M1</b>	○ 1/4 - ● 1/4

## BW 2400S 7/E-M

Werkzeugwagen mit 7 Schubladen, mit  
Werkzeugsortiment, 309-teilig

Haupteigenschaften:

- 7 Schubladen, 588x367 mm, mit Teleskopführungen, kugelgelagert:
- 5 Schubladen Höhe 70 mm
- 1 Schublade Höhe 140 mm
- 1 Schublade Höhe 210 mm
- Schubladenböden mit Schaumgummibelag
- 4 Räder Ø 125 mm:
- 2 starre und 2 lenkbare (eines mit Bremse)
- Zentralverriegelung mit vorderem Sicherheitsschloss
- Statische Belastung: 800 kg
- Thermokunststoff-Arbeitsplatte
- Integrierter seitlicher Flaschenhalter

X  
309

800 kg



€ 1.464,00 inkl. MwSt.  
**€ 1.220,00**



024006224



024006225



024006226

n°	h	max
5	70 mm	25 kg
1	140 mm	30 kg
1	210 mm	30 kg

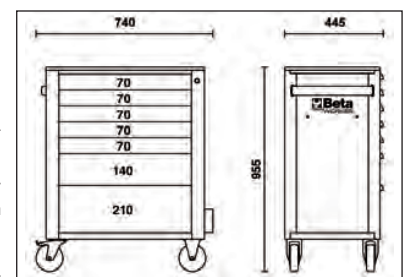
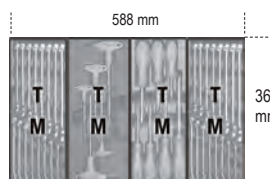
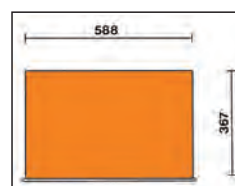

Frontblende aus  
hochbeständigem  
Nylon



Räder mit  
Metallkern für höhere  
Widerstandsfähigkeit







13

- BW 32 Ø 4 mm
- BW 34 150 mm
- BW 36 150 mm
- 1032 ○ 19+60 mm
- 1034 ○ 19+60 mm
- 1036 ● 19+60 mm
- 1038 ● 19+60 mm
- BW 1048 250 mm
- BW 1082BM ⚡ 160 mm
- BW 1150BM = 180 mm
- BW 1166BM ● 200 mm
- BW 1370 ● 500 g
- BW 1390 Ø 35 mm



31

- BW 42 6-7-8-9-10-11-12-13-14-15-16-17-18-19-20-21-22-23-24-27-30-32 mm
- BW 96BPC/SC9 ○ 1,5-2-2,5-3-4-5-6-8-10 mm



159

14

- BW 900 ○ 4-4,5-5-5,5-6-7-8-9-10-11-12-13-14 mm
- BW 900L ○ 4-4,5-5-5,5-6-7-8-9-10-11-12-13-14 mm
- BW 900ME ○ 3-4-5-6-7-8 mm
- BW 900TX ○ T6-T7-T8-T9-T10-T15-T20-T25
- BW 895/1 ○ 1/4 - □ 1/4
- BW 900/20 50 mm
- BW 900/20L 100 mm
- BW 900/25 150 mm
- BW 900/30 150 mm
- BW 900/42 115 mm
- BW 900/55 ⊗ 150 mm

12

- BW 920A ○ 8-9-10-11-12-13-14-15-16-17-18-19-20-21-22-23-24-27-30-32 mm
- BW 920AL ○ 10-12-13-14-15-16-17-18-19-21-22 mm
- BW 920PE ○ 5-6-7-8-9-10-12-14 mm
- BW 920TX ○ T27-T30-T40-T45-T50-T55-T60
- BW 920/21 125 mm
- BW 920/22 250 mm
- BW 910/16F □ 3/8" - ■ 1/2"
- BW 920/25
- BW 920/55 ⊗ 260 mm

**BW 861/C61 14**

⊖	BW 861LP	0,5x3 (2)-0,5x4(2)-0,6x4,5(2)-0,8x5(2)-1,0x5,5(2)-1,0x6(2)-1,6x8(2) mm
+	BW 861PH	PH0(2)-PH1(7)-PH2(7)-PH3(2)
+	BW 861PZ	PZ0(2)-PZ1(3)-PZ2(3)-PZ3(2)
○	BW 861PE	1,5-2-2,5-3-4-4,5-5-5,5-6-8 mm
⊗	BW 861TX	T9-T10-T15-T20-T25 T27-T30-T40
□	BW 882M1	○ 1/4 - ● 1/4



60

- 38** BW 55 6x7-8x9-10x11-12x13-14x15-16x17-18x19-20x22 mm
- BW 90 6x7-8x9-10x11-12x13-14x15-16x17-18x19-20x22 mm
- BW 910A ○ 6-7-8-9-10-11-12-13-14-15-16-17-18-19-20-21-22 mm
- BW 910AL ○ 8-10-11-12-13-14-17-19 mm
- BW 910PE ○ 4-5-6-7-8-9-10 mm
- BW 910TX ○ T15-T20-T25-T27-T30-T40-T45
- BW 910/21 125 mm
- BW 910/22 150 mm
- BW 910/25
- BW 910/55 ⊗ 205 mm
- BW 920/15F □ 1/2" - ■ 3/8"



46

- 1201E ● 2,5x50-3x75-4x100-5,5x125-6,5x150-8x200 mm
- 1202E + PH0x60-PH1x80-PH2x100-PH3x150 mm
- 1201EN ● 4x30 mm
- 1202EN + PH1x30 mm
- 1207E/TX ○ T6-T7-T8-T9-T10-T15-T20-T25-T27-T30-T40-T45

**BW 1256/C21-1 4mm**

⊖	BW 1256LP	1,5-2-2,5 mm
+	BW 1256PH	PH0-PH1
+	BW 1256PZ	PZ0-PZ1
○	BW 1256PE	0,7-0,9-1,3-1,5-2-2,5-3 mm
⊗	BW 1256TX	T4-T5-T6-T7
⊗	BW 1256RTX	T8-T10-T15
4 mm		99 mm



800 kg

## BW 2400S 8/E-L

Werkzeugwagen mit 8 Schubladen, mit Werkzeugsortiment, 398-teilig

Haupteigenschaften:

- 8 Schubladen, 588x367 mm, mit Teleskopführungen, kugelgelagert:
- 7 Schubladen Höhe 70 mm
- 1 Schublade Höhe 210 mm
- Schubladenböden mit Schaumgummibelag
- 4 Räder Ø 125 mm
- 2 starre und 2 lenkbare (eines mit Bremse)
- Zentralverriegelung mit vorderem Sicherheitsschloss
- Statische Belastung: 800 kg
- Thermokunststoff-Arbeitsplatte
- Integrierter seitlicher Flaschenhalter

€ 1.938,00 inkl. MwSt.  
**€ 1.615,00**



024006241



024006242



024006243



n°	h	max
7	70 mm	25 kg
1	210 mm	30 kg

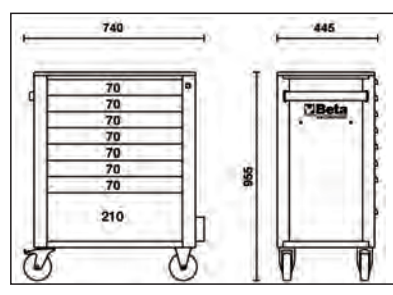
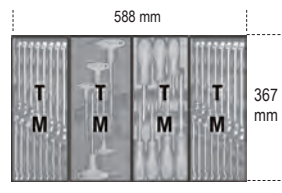
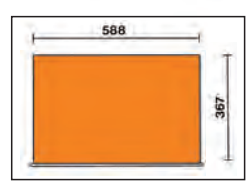

**31**

BW 42 6-7-8-9-10-11-12-13-14-15-16-17-18-19-20-21-22-23-24-27-30-32 mm  
 BW 96BPC/SC9 1,5-2-2,5-3-4-5-6-8-10 mm



**25**

1201E ● 2,5x50-3x75-4x100-5,5x125-6,5x150-8x200 mm  
 1201EN ● 4x30 mm  
 1202E ⊕ PH0x60-PH1x80-PH2x100-PH3x150 mm  
 1202EN ⊕ PH1x30 mm  
 1207E/TX ⊖ T6-T7-T8-T9-T10-T15-T20-T25-T27-T30-T40-T45  
 BW 1253 ● 0,5x100 mm



196



- 14"**
- BW 900 ○ 4-4,5-5-5,5-6-7-8-9-10-11-12-13-14 mm
  - BW 900L ○ 4-4,5-5-5,5-6-7-8-9-10-11-12-13-14 mm
  - BW 900FTX ○ E4-E5-E6-E7-E8-E10
  - BW 900ME ○ 3-4-5-6-7-8 mm
  - BW 900TX ○ T6-T7-T8-T9-T10-T15-T20-T25
  - BW 900LP ● 0,8x4-1x5,5-1,2x6,5-1,2x8 mm
  - BW 900PH ○ PH0-PH1-PH2-PH3
  - BW 895/1 ○ 1/4" - □ 1/4"
  - BW 900/20 50 mm
  - BW 900/20L 100 mm
  - BW 900/25 150 mm
  - BW 900/30 150 mm
  - BW 900/42 115 mm
  - BW 900/55 ● 150 mm

- 38"**
- BW 910A ○ 6-7-8-9-10-11-12-13-14-15-16-17-18-19-20-21-22-24 mm
  - BW 910AL ○ 8-10-11-12-13-14-17-19 mm
  - BW 910FTX ○ E6-E7-E8-E10-E11-E12-14
  - BW 910PE ○ 4-5-6-7-8-9-10 mm
  - BW 910TX ○ T15-T20-T25-T27-T30-40-T45
  - BW 910/21 125 mm
  - BW 910/22 150 mm
  - BW 910/25 ● 205 mm
  - BW 910/55 ● 205 mm
  - BW 920/15F □ 1/2" - ■ 3/8"

**BW 861/C61**

●	BW 861LP	0,5x3 (2)-0,5x4(2)-0,6x4,5(2)-0,8x5(2)-1,0x5,5(2)-1,0x6(2)-1,6x8(2) mm
+	BW 861PH	PH0(2)-PH1(7)-PH2(7)-PH3(2)
+	BW 861PZ	PZ0(2)-PZ1(3)-PZ2(3)-PZ3(2)
○	BW 861PE	1,5-2-2,5-3-4-4,5-5-5,5-6-8 mm
⊗	BW 861TX	T9-T10-T15-T20-T25 T27-T30-T40
○	BW 882M1	○ 1/4 - ● 1/4

**BW 1256/C21-1**

●	BW 1256LP	1,5-2-2,5 mm
+	BW 1256PH	PH0-PH1
+	BW 1256PZ	PZ0-PZ1
○	BW 1256PE	0,7-0,9-1,3-1,5-2-2,5-3 mm
⊗	BW 1256TX	T4-T5-T6-T7
⊗	BW 1256RTX	T8-T10-T15
4 mm		99 mm

78

**12"**

- BW 920A ○ 8-9-10-11-12-13-14-15-16-17-18-19-20-21-22-23-24-27-30-32 mm
- BW 920AL ○ 10-12-13-14-15-16-17-18-19-21-22-24-27-30-32 mm
- BW 920FTX ○ E10-E12-E14-E16-E18-E20-E22-E24
- BW 920PE ○ 5-6-7-8-9-10-12-14 mm
- BW 920PE-L ○ 5-6-7-8-9-10-12-14 mm
- BW 920TX ○ T27-T30-T40-T45-T50-T55-T60
- BW 920TX-L ○ T30-T40-T45-T50-T55-T60-T70
- BW 920/21 125 mm
- BW 920/22 250 mm
- BW 910/16F □ 3/8" - ■ 1/2"
- BW 920/25 ● 260 mm
- BW 920/55 ● 260 mm

30

- BW 55 ○ 6x7-8x9-10x11-12x13-14x15-16x17-18x19-20x22-21x23-24x27-30x32 mm
- BW 90 ○ 6x7-8x9-10x11-12x13-14x15-16x17-18x19-20x22-21x23-24x27-30x32 mm
- BW 97TX/SC8 ○ T9-T10-T15-T20-T25-T27-T30-T40

13

- 1032 ○ 19+60 mm
- 1034 ○ 19+60 mm
- 1036 ● 19+60 mm
- 1038 ● 19+60 mm
- BW 1048 250 mm
- BW 1052 190 - 240 mm
- BW 1098 220 mm
- BW 1082BM ≡ 160 mm
- BW 1150BM ≡ 180 mm
- BW 1166BM ● 200 mm
- BW 1168BM ● 200 mm
- BW 1128BMX 150 mm

25

- BW 30 Ø 2-3-4 mm
- BW 31 Ø 2-3-4-5-6-8 mm
- BW 32 Ø 4 mm
- BW 34 125-150-175 mm
- BW 36 150 mm
- BW 1370 500 g
- BW 1390 Ø 35 mm
- BW 1692/3 3 m
- BW 1712T 150+590 mm
- BW 1719BMA8/Q ■ 200 mm
- BW 1719BMA8/T ▲ 200 mm
- BW 1719BMA8/P I 200 mm
- BW 1719BMA8/M ▽ 200 mm
- BW 1719BMA8/R ● 200 mm
- BW 1737NX 270 mm
- 1771 18 mm

**X**  
**487**

## BW 2400S XL9/E-XL

Werkzeugwagen mit 9 Schubladen, mit Anti-Kipp-System, lange Ausführung, mit Werkzeugsortiment, 487-teilig

Haupteigenschaften:

- 9 Schubladen, 882x367 mm, mit Teleskopführungen, kugelgelagert:  
8 Schubladen Höhe 70 mm  
1 Schublade Höhe 140 mm
- Arbeitsplatte aus hochbeständigem ABS, mit 6 Schalen zur Aufnahme von Kleinteilen
- Frontblende aus hochbeständigem Nylon, mit integriertem Etikettenrahmen
- Schubladenböden mit Schaumgummibelag
- 4 Räder Ø 125 mm:  
2 starre und 2 lenkbare (eines mit Bremse)
- Zentralverriegelung mit vorderem Sicherheitsschloss
- Statische Belastung: 1.000 kg
- Integrierter seitlicher Flaschenhalter

1000 kg



€ 2.880,00 inkl. MwSt.

**€ 2.400,00**



024006251



024006252



024006253



n°	h	max
8	70 mm	30 kg
1	140 mm	35 kg

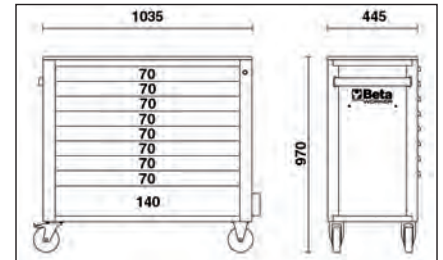
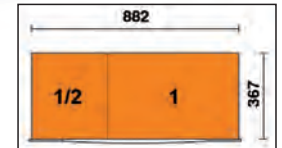

196



14"	BW 900	○ 4-4,5-5-5,5-6-7-8-9-10-11-12-13-14 mm
	BW 900L	○ 4-4,5-5-5,5-6-7-8-9-10-11-12-13-14 mm
	BW 900FTX	⊗ E4-E5-E6-E7-E8-E10
	BW 900ME	○ 3-4-5-6-7-8 mm
	BW 900TX	○ T6-T7-T8-T9-T10-T15-T20-T25
	BW 900LP	● 0,8x4-1x5,5-1,2x6,5-1,2x8 mm
	BW 900PH	⊗ PH0-PH1-PH2-PH3
	BW 895/1	○ 1/4" - □ 1/4"
	BW 900/20	50 mm
	BW 900/20L	100 mm
	BW 900/25	
	BW 900/30	150 mm
	BW 900/42	115 mm
	BW 900/55	⊗ 150 mm

38"	BW 910A	○ 6-7-8-9-10-11-12-13-14-15-16-17-18-19-20-21-22-24 mm
	BW 910AL	○ 8-10-11-12-13-14-17-19 mm
	BW 910FTX	⊗ E6-E7-E8-E10-E11-E12-14
	BW 910PE	○ 4-5-6-7-8-9-10 mm
	BW 910TX	○ T15-T20-T25-T27-T30-40-T45
	BW 910/21	125 mm
	BW 910/22	150 mm
	BW 910/25	
	BW 910/55	⊗ 205 mm
	BW 920/15F	□ 1/2" - ■ 3/8"

### BW 861/C61

⊖	BW 861LP	0,5x3 (2)-0,5x4(2)-0,6x4,5(2)-0,8x5(2)-1,0x5,5(2)-1,0x6(2)-1,6x8(2) mm
+	BW 861PH	PH0(2)-PH1(7)-PH2(7)-PH3(2)
+	BW 861PZ	PZ0(2)-PZ1(3)-PZ2(3)-PZ3(2)
○	BW 861PE	1,5-2-2,5-3-4-4,5-5-5,5-6-8 mm
⊗	BW 861TX	T9-T10-T15-T20-T25 T27-T30-T40
□	BW 882M1	○ 1/4 - ● 1/4

### BW 1256/C21-1

⊖	BW 1256LP	1,5-2-2,5 mm
+	BW 1256PH	PH0-PH1
+	BW 1256PZ	PZ0-PZ1
○	BW 1256PE	0,7-0,9-1,3-1,5-2-2,5-3 mm
⊗	BW 1256TX	T4-T5-T6-T7
⊗	BW 1256RTX	T8-T10-T15
4 mm		99 mm





**BW 42** ○ 6-7-8-9-10-11-12-13-14-15-16-17-18-19-20-21-22-23-24-27-30-32 mm  
**BW 96BPC/ISC9** ○ 1,5-2-2,5-3-4-5-6-8-10 mm



**BW 55** ○ 6x7-8x9-10x11-12x13-14x15-16x17-18x19-20x22-21x23-24x27-30x32 mm  
**BW 90** ○ 6x7-8x9-10x11-12x13-14x15-16x17-18x19-20x22-21x23-24x27-30x32 mm  
**BW 97TX/SC8** ○ T9-T10-T15-T20-T25-T27-T30-T40



**1032** ○ 19+60 mm **BW 1098** 220 mm  
**1034** ○ 19+60 mm **BW 1082BM** 160 mm  
**1036** ● 19+60 mm **BW 1150BM** 180 mm  
**1038** ● 19+60 mm **BW 1166BM** 200 mm  
**BW 1048** 250 mm **BW 1168BM** 200 mm  
**BW 1052** 190 - 240 mm **BW 1128BMX** 150 mm



**BW 920A** ○ 8-9-10-11-12-13-14-15-16-17-18-19-20-21-22-23-24-27-30-32 mm  
**BW 920AL** ○ 10-12-13-14-15-16-17-18-19-21-22-24-27-30-32 mm  
**BW 920FTX** ○ E10-E12-E14-E16-E18-E20-E22-E24  
**BW 920PE** ○ 5-6-7-8-9-10-12-14 mm  
**BW 920PE-L** ○ 5-6-7-8-9-10-12-14 mm  
**BW 920TX** ○ T27-T30-T40-T45-T50-T55-T60  
**BW 920TX-L** ○ T30-T40-T45-T50-T55-T60-T70  
**BW 920/21** 125 mm  
**BW 920/22** 250 mm  
**BW 910/16F** □ 3/8" - ■ 1/2"  
**BW 920/25**  
**BW 920/55** ⊕ 260 mm



**1201E** ● 2,5x50-3x75-4x100-5,5x125-6,5x150-8x200 mm  
**1201EN** ● 4x30 mm  
**1202E** ⊕ PH0x60-PH1x80-PH2x100-PH3x150 mm  
**1202EN** ⊕ PH1x30 mm  
**1207E/TX** ⊕ T6-T7-T8-T9-T10-T15-T20-T25-T27-T30-T40-T45  
**BW 1253** ● 0,5x100 mm



**BW 720** ○ 10-12-13-15-17-19-21-24 mm  
**BW 720L** ○ 17-19-21-22 mm  
**BW 720/21** 125 mm  
**BW 900/16** □ 1/4" - ■ 3/8"  
**BW 910/15** □ 3/8" - ■ 1/4"  
**BW 910/16F** □ 3/8" - ■ 1/2"  
**BW 920/15F** □ 1/2" - ■ 3/8"  
**BW 920/16** □ 1/2" - ■ 3/4"  
**BW 943FL** ⊕ 6-7-8 mm  
**BW 1687D** 153 mm  
**BW 1687U** 153 mm  
**BW 1687A** 153 mm  
**BW 1687AC** 153 mm



**BW 1370** 500 g  
**BW 1380** 1000 g  
**BW 1390** Ø 35 mm  
**BW 1737NX**



**BW 141** ○ 8-9-10-11-12-13-14-15-17-19 mm  
**BW 410/SP19** Ø 1+10 mm x 0.5 mm  
**BW 1725CR** 260 mm

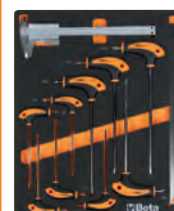

**BW 97TTX** ○ T8-T9-T10-T15-T20-T25-T27-T30-T40  
**BW 1682** 300 mm  
**BW 1650** 150 mm



**943E** ○ 6-7-8-9-10-11-12-13 mm



**BW 30** Ø 2-3-4 mm **BW 1719BMA8/T** ▲ 200 mm  
**BW 31** Ø 2-3-4-5-6-8 mm **BW 1719BMA8/P** ▮ 200 mm  
**BW 32** Ø 4 mm **BW 1719BMA8/M** ▽ 200 mm  
**BW 34** 125-150-175 mm **BW 1719BMA8/R** ● 200 mm  
**BW 1692/3** 3 m **BW 1719BMA8/Q** ■ 200 mm  
**BW 1712T** 150+590 mm **BW 1771** 18 mm  
**BW 1725** 420 mm **BW 1833S** 200 lumen



**BW 1149F** 175 mm  
**BW 1602** 0,75+6 mm<sup>2</sup>  
**BW 1603** 1,25+5,5 mm<sup>2</sup>  
**BW 1606T** 0,1+10 mm<sup>2</sup>  
**BW 1608** 0,5+6 mm<sup>2</sup>



**BW 96T** ○ 2-2,5-3-4-5-6-7-8 mm

1000 kg

## BW 2400S XL9/E-XXL

Werkzeugwagen mit 9 Schubladen, mit Anti-Kipp-System, lange Ausführung, mit Werkzeugsortiment, 716-teilig

Haupteigenschaften:

- 9 Schubladen, 882x367 mm, mit Teleskopführungen, kugelgelagert:
- 8 Schubladen Höhe 70 mm
- 1 Schublade Höhe 140 mm
- Arbeitsplatte aus hochbeständigem ABS, mit 6 Schalen zur Aufnahme von Kleinteilen
- Frontblende aus hochbeständigem Nylon, mit integriertem Etikettenrahmen
- Schubladenböden mit Schaumgummibelag
- 4 Räder Ø 125 mm:
- 2 starre und 2 lenkbare (eins mit Bremse)
- Zentralverriegelung mit vorderem Sicherheitsschloss
- Statische Belastung: 1.000 kg
- Integrierter seitlicher Flaschenhalter



€ 3.480,00 inkl. MwSt.

**€ 2.900,00**



024006254



024006255



024006256



n°	h	max
8	70 mm	30 kg
1	140 mm	35 kg

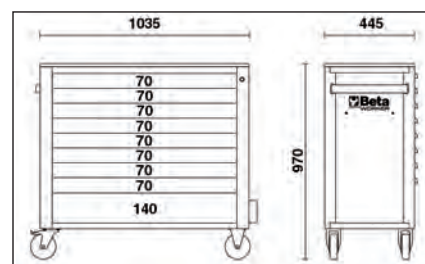
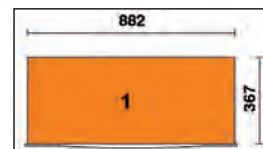

214



BW 97TX/SC8 ○ T9-T10-T15-T20-T25-T27-T30-T40  
 BW 97TTX ○ T8-T9-T10-T15-T20-T25-T27-T30-T40

**3/8"** BW 910A ○ 6-7-8-9-10-11-12-13-14-15-16-17-18-19-20-21-22-24 mm  
 BW 910AL ○ 8-10-11-12-13-14-17-19 mm  
 BW 910FTX ⊗ E6-E7-E8-E10-E11-E12-E14  
 BW 910PE ○ 4-5-6-7-8-9-10 mm  
 BW 910TX ○ T15-T20-T25-T27-T30-T40-T45

BW 910/20 75 mm  
 BW 910/22 150 mm  
 BW 910/25  
 BW 910/55 ⊕ 200 mm  
 BW 920/15F □ 1/2" - ■ 3/8"

**1/4"** BW 900 ○ 4-4,5-5-5,5-6-7-8-9-10-11-12-13-14 mm  
 BW 900L ○ 4-4,5-5-5,5-6-7-8-9-10-11-12-13-14 mm  
 BW 900FTX ⊗ E4-E5-E6-E7-E8-E10  
 BW 900ME ○ 3-4-5-6-7-8-10 mm  
 BW 900TX ○ T6-T7-T8-T9-T10-T15-T20-T25  
 BW 900LP ● 0,8x4-1,0x5,5-1,2x6,5-1,2x8 mm

BW 900PH ⊕ PH0-PH1-PH2-PH3  
 BW 895/1 ⊕ PH  
 BW 900/20 50 mm  
 BW 900/20L 100 mm  
 BW 900/25  
 BW 900/30 150 mm  
 BW 900/42 115 mm  
 BW 900/55 ⊕ 150 mm

### BW 861/C61

●	BW 861LP	0,5x3 (2)-0,5x4(2)-0,6x4,5(2)-0,8x5(2)-1,0x5,5(2)-1,0x6(2)-1,6x8(2) mm
⊕	BW 861PH	PH0(2)-PH1(7)-PH2(7)-PH3(2)
⊕	BW 861PZ	PZ0(2)-PZ1(3)-PZ2(3)-PZ3(2)
○	BW 861PE	1,5-2-2,5-3-4-4,5-5-5,5-6-8 mm
⊕	BW 861TX	T9-T10-T15-T20-T25 T27-T30-T40
○	BW 882M1	1/4 - 1/4

### BW 1256/C21-1

○	BW 1256LP	1,5-2-2,5 mm
⊕	BW 1256PH	PH0-PH1
⊕	BW 1256PZ	PZ0-PZ1
○	BW 1256PE	0,7-0,9-1,3-1,5-2-2,5-3 mm
⊕	BW 1256TX	T4-T5-T6-T7
⊕	BW 1256RTX	T8-T10-T15
4 mm		99 mm





97

- 12"**
- BW 720L ○ 10-12-13-15-17-19-21-24-27-30 mm
  - BW 720/21 125 mm
  - BW 720/25 64 mm
  - BW 910/16F □ 3/8" - ■ 1/2"
  - BW 920/16 □ 1/2" - ■ 3/4"
  - BW 920A ○ 8-9-10-11-12-13-14-15-16-17-18-19-20-21-22-23-24-27-30-32 mm
  - BW 920AL ○ 10-12-13-14-15-16-17-18-19-21-22-24-27-30-32 mm
  - BW 920FTX ○ E10-E12-E14-E16-E18-E20-E22-E24
  - BW 920PE ○ 5-6-7-8-9-10-12-14 mm
  - BW 920PE-L ○ 5-6-7-8-9-10-12-14 mm
  - BW 920PE-XL ○ 10-12-14 mm
  - BW 920TX ○ T27-T30-T40-T45-T50-T55-T60
  - BW 920TX-L ○ T30-T40-T45-T50-T55-T60-T70
  - BW 920TX-XL ○ T45-T50-T55
  - BW 920/21 125 mm
  - BW 920/22 250 mm
  - BW 920/25 ○ 260 mm
  - BW 920/55 ○ 260 mm



35

- 943E ○ 5-5.5-6-7-8-9-10-11-12-13-14 mm
- 1201E ● 2,5x50-3x75-4x100-5,5x125-6,5x150-8x200 mm
- 1202E ● PH0x60-PH1x80-PH2x100-PH3x150 mm
- 1201EN ● 4x30 mm
- 1202EN ● PH1x30 mm
- 1207E/TX ○ T6-T7-T8-T9-T10-T15-T20-T25-T27-T30-T40-T45



235

- BW 96BPC/SC9 ○ 1,5-2-2,5-3-4-5-6-8-10 mm
- BW 410/SP19 1+10 mm x 0,5 mm
- BW 666N/20 40÷20 Nm
- BW 720 ○ 10-12-13-15-17-19-21-24-27-30 mm
- BW 867PE ○ 4-5-6-7-8-10-12 mm
- BW 867PE/L ○ 4-5-6-7-8-10-12 mm
- BW 867XZN ○ 4-5-6-7-8-10-12 mm
- BW 867XZN/L ○ 5-6-8-10-12 mm
- BW 867TX ○ T20-T25-T30-T40-T45-T50-T55
- BW 867TX/L ○ T20-T25-T30-T40-T45-T50-T55
- BW 867RTX ○ T20-T25-T30-T40-T45-T50-T55
- BW 867RTX/L ○ T20-T25-T30-T40-T45-T50-T55
- BW 867/1 ○ 10 mm - □ 3/8"
- BW 867/2 ○ 10 mm - □ 1/2"
- BW 867RIBE ○ 5-6-7-8-9-10-11-12-13 mm
- BW 867RIBE/L ○ 5-6-7-8-9-10-11-12-13 mm
- BW 1253 ● 0,5x100 mm
- BW 1257LP ● 2,0-2,5-3,0 mm
- BW 1257PH ● PH00-PH0-PH1
- BW 1257TX ○ T5-T6-T7-T8-T9-T10
- BW 1728BM
- BW 1728LA

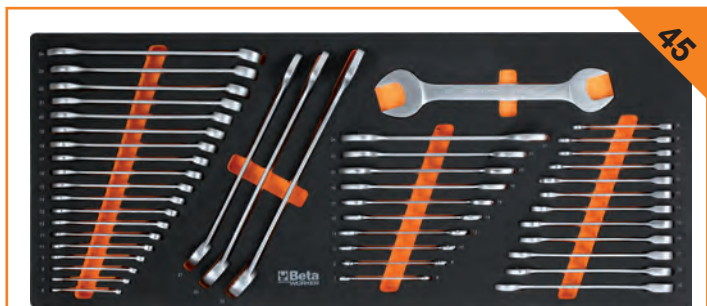

45

- BW 42 ○ 6-7-8-9-10-11-12-13-14-15-16-17-18-19-20-21-22-23-24-27-30-32 mm
- BW 55 ○ 6x7-8x9-10x11-12x13-14x15-16x17-18x19-20x22-21x23-24x27-30x32 mm
- BW 141 ○ 8-9-10-11-12-13-14-15-16-17-18-19 mm



30

- BW 90 ○ 6x7-8x9-10x11-12x13-14x15-16x17-18x19 mm
- BW 96T ○ 2-2,5-3-4-5-6-7-8-10 mm
- BW 1098 220 mm
- BW 1650 150 mm
- BW 1682 300 mm
- BW 1687/S4
- BW 192 8x10/12x13 mm
- BW 192 16x17/18x19 mm
- BW 1719BMA8/Q ■ 200 mm
- BW 1719BMA8/T ▲ 200 mm
- BW 1719BMA8/P ▨ 200 mm
- BW 1719BMA8/M ▩ 200 mm
- BW 1719BMA8/R ● 200 mm



33

- BW 943FL ○ 6-7-8 mm
- BW 1692/5 5 m
- BW 1712T 148+665 mm
- BW 1606T 0,08+6 mm<sup>2</sup>
- BW 1608 0,5+6 mm<sup>2</sup>
- BW 1725 420 mm
- BW 1725CR 250 mm
- BW 1737NX
- 1771 18 mm
- BW 1771RL 10x 18 mm
- BW 1833S 200 lumen
- BW 1715
- BW 1720/B6
- BW 1128BMX 150 mm
- BW 1149F 0,2+6 mm<sup>2</sup>
- BW 1602 0,75+6 mm<sup>2</sup>
- BW 1603 1,25+5,5 mm<sup>2</sup>

059456301

# BW 5945/2023

Werkzeugsortiment, 268-teilig,  
im Schaumstoffeinsatz aus EVA

€ 1.218,00 inkl. MwSt.

**€ 1.015,00**

**X  
268**



Passend für **C45PRO**

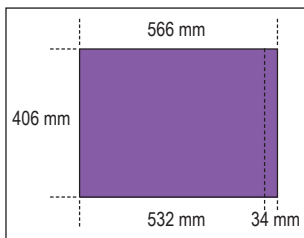

**17**

- BW 96T ○ 2-2,5-3-4-5-6-7-8 mm
- BW 34 150-175 mm
- BW 1370 300 g
- BW 1390 Ø 35 mm
- BW 1719BMA8/Q ▲ 200 mm
- BW 1719BMA8/T ▲ 200 mm
- BW 1719BMA8/P ▲ 200 mm
- BW 1719BMA8/M ▲ 200 mm
- BW 1719BMA8/R ● 200 mm



**30**

- BW 96BPC/SC9 ○ 1,5-2-2,5-3-4-5-6-8-10 mm
- BW 42 ○ 6-7-8-9-10-11-12-13-14-15-16-17-18-19-20-21-22-24-27-30-32 mm



- BW 97TTX ○ T10-T15-T20-T25-T30
- 1038 ● 19+60 mm
- 1036 ● 19+60 mm
- 1034 ○ 19+60 mm
- 1032 ○ 19+60 mm
- BW 1166BM ● 160 mm
- BW 1150BM = 180 mm
- BW 1082BM ▲ 160 mm
- BW 1052 240 mm
- BW 1048 250 mm

**36**

## BW 1256/C21-1

4 mm	BW 1256LP	1,5-2-2,5 mm
	BW 1256PH	PH0-PH1
	BW 1256PZ	PZ0-PZ1
	BW 1256PE	0,7-0,9-1,3-1,5-2-2,5-3 mm
	BW 1256TX	T4-T5-T6-T7
	BW 1256RTX	T8-T10-T15
		99 mm



- 1202E ○ PH0x60-PH1x80-PH2x100-PH3x150 mm
- 1202EN ○ PH1X30 mm
- 1207E/TX ○ T6-T7-T8-T9-T10-T15-T20-T25-T27-T30-T40-T45
- 1201EN ● 4x30 mm
- 1201E ● 2,5x50-3x75-4x100-5,5x125-6,5x150-8x200 mm
- BW 1253 ● 3x100 mm

**25**



**160**

- 1/4"** BW 900 ○ 4-4,5-5-5,5-6-7-8-9-10-11-12-13-14 mm
- BW 900L ○ 5-6-7-8-9-10-11-12-13 mm
- BW 900LP ● 0,8x4-1,0x5,5-1,2x6,5-1,2x8,0 mm
- BW 900PH ○ PH1-PH2-PH3
- BW 900ME ○ 3-4-5-6-7 mm
- BW 900TX ○ T10-T15-T20-T25-T27-T30
- BW 900/20 50 mm
- BW 900/20L 100 mm
- BW 900/25 150 mm
- BW 900/30 150 mm
- BW 895/1 ○ 1/4" - □ 1/4"
- BW 895/3 ○ 1/4" - □ 3/8"
- BW 895/6 ○ 5/16" - □ 1/2"
- BW 900/42 115 mm
- BW 900/55 ● 150 mm

- 1/2"** BW 895/6 ○ 5/16" - □ 1/2"
- BW 956C ○ 16 mm - 20,8 mm
- BW 920/15F ○ 1/2" - ■ 3/8"
- BW 910/22 150 mm
- BW 910/55 ● 205 mm
- BW 920/55 ● 260 mm
- BW 920A ○ 8-10-11-12-13-14-15-16-17-18-19-20-21-22-23-24-26-27-28-30-32 mm
- BW 920/25 125 mm
- BW 920/21 125 mm
- BW 920/22 255 mm

## BW 861/C61

●	BW 861LP	0,5x3 (2)-0,5x4(2)-0,6x4,5(2)-0,8x5(2)-1,0x5,5(2)-1,0x6(2)-1,6x8(2) mm
+	BW 861PH	PH0(2)-PH1(7)-PH2(7)-PH3(2)
+	BW 861PZ	PZ0(2)-PZ1(3)-PZ2(3)-PZ3(2)
○	BW 861PE	1,5-2-2,5-3-4-4,5-5-5,5-6-8 mm
○	BW 861TX	T9-T10-T15-T20-T25 T27-T30-T40
○	BW 882M1	○ 1/4 - ● 1/4

- 3/8"** BW 895/6 ○ 5/16" - □ 1/2"
- BW 910A ○ 6-7-8-9-10-11-12-13-14-15-16-17-18-19-20-21-22 mm
- BW 910/20 75 mm
- BW 910/22 150 mm
- BW 910/25 150 mm
- BW 910/16F □ 3/8" - ■ 1/2"





# **Beta** WORKER

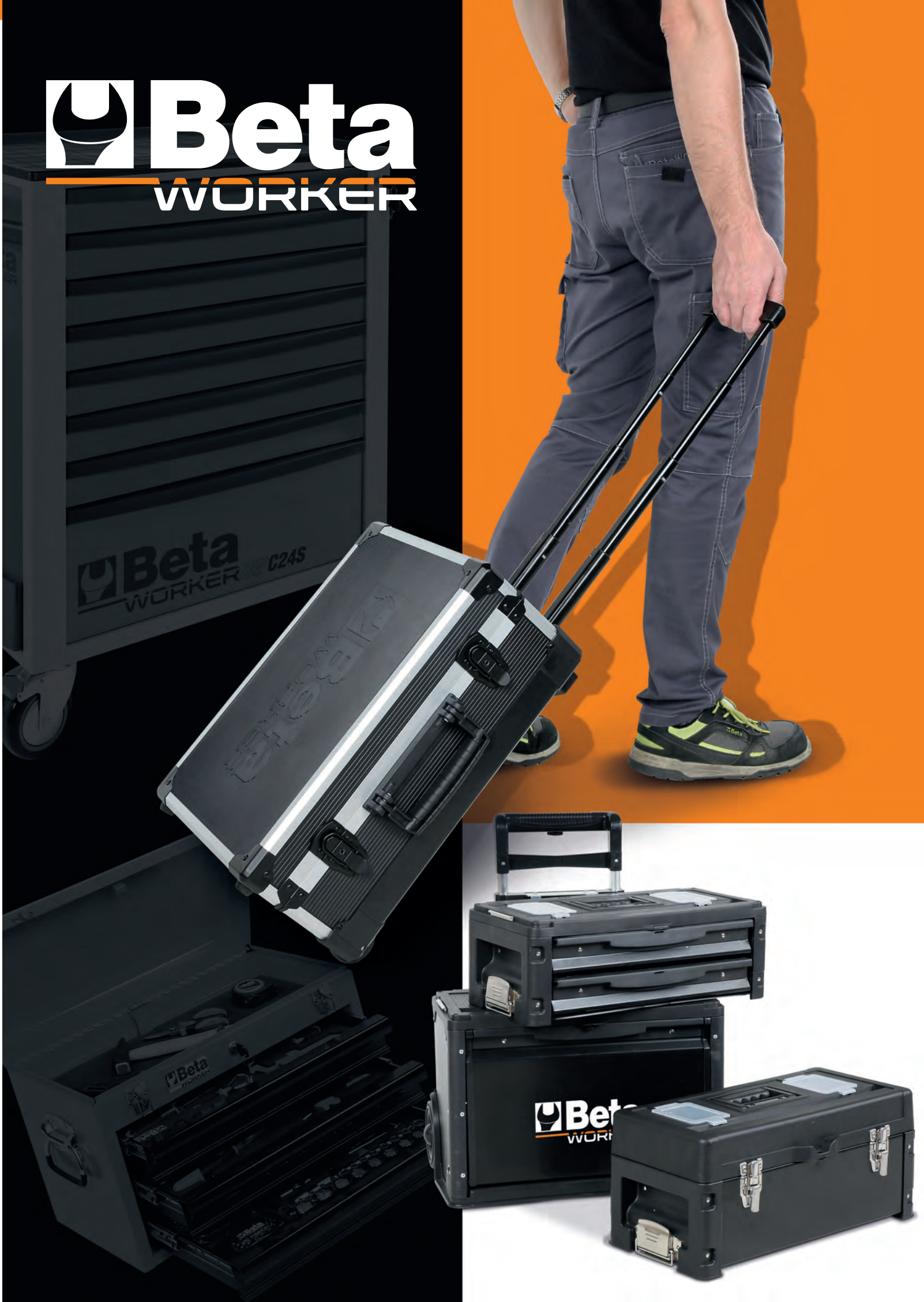



Unverbindliche Verkaufspreise exkl. und inkl. gesetzlicher MwSt. Preis-, Satz- und Druckfehler sowie technische Änderungen vorbehalten



# TAZOLL GMBH

BATTERIEN & WERKZEUGE